



Sovitron Interior Pvt.Ltd.



Model Name	URBANA-2112C / DL-OSL-2112CA-12
Description	Inground Light

Technical description	Image
-----------------------	-------

Dimension	Outer Dia=210mm Cutout=145mm H=120mm
Frame	Aluminum die cast
Color Tempertaure	4000K
Power	14W
Total Luminous Flux	910 lm
Efficacy	65 lm/W
IP rating	67
Color Rendering	≥80
Mounting	Buried
Beam angle	5,12.5,20,30, 45, 60,15X30,10X60 Degree
Optics	Tempered glass
Dimming	NON-Dimmable
Operating Voltage	220-240 VAC
Standard Lifetime	L70 minimum at 50,000 burning hours



Dimension diagram

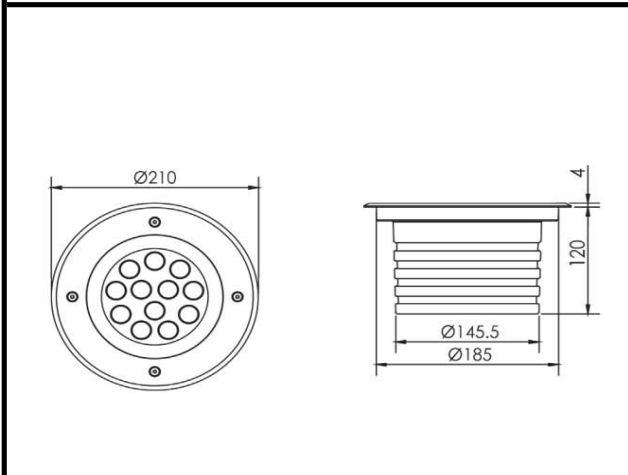

Remarks:-

Address: Plot #7 Saroorpur-Nangla Industrial Area,Ballabgarh-Sohna Road,Faridabad-121005
Email: info@sovitron.com